



**OPTIMIZER® DEV AND DI CARTRIDGE  
AND DISPOSABLE FILTERS**

*UPE integrated filters designed for point-of-use developer  
and DI water applications in photolithography*



# designed for point-of-use developer and DI water applications in photolithography

## Overview

Developed from Entegris' microcontamination control technologies, Optimizer® filters do not require prewetting. These filters avoid the associated problems of incomplete wetting (reduced flow and increased pressure drop), mixing of incompatible chemicals and the time wasted to wet and flush filters.

### The Solution for Point-of-Use Developer and DI Water Applications

The Optimizer DEV and DI point-of-use filters meet small- to mid-volume photochemical filtration needs for positive developer and DI water applications.

### Eliminates Prewetting and Reduces Downtime

Optimizer filters use Entegris' patented ultra-high molecular weight polyethylene (UPE) membrane. This surface-modified UPE membrane matches the surface energies and surface tensions of the base fluids.

By adjusting the membranes' critical surface energy higher than the base solvent these filters minimize the potential for dewetting, optimize the full use of the membrane and ensure maximum flow. Because the membrane remains fully wet, Optimizer filters also reduce the chances of microbubble formation.

Both Optimizer DEV filters (for DI water and developer applications) and Optimizer DI filters (for DI water applications) require no prewetting, so the filters function immediately after installation.

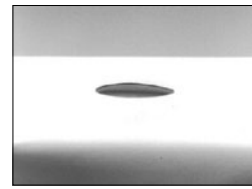

*UPE membrane: water or developer wets within ten seconds*

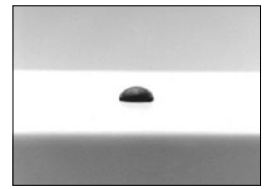

*PTFE membrane: resists instantaneous wetting*

Features	Benefits
Surface-modified UPE membrane	Requires no prewetting. Rapidly wets and remains fully wet in water or developer. Eliminates chemical usage while reducing system downtime during filter changeouts. Saves time, greatly increases equipment uptime.
Disposable filters designed without o-rings	High-purity o-ringless connections avoid potential sources of contamination.
Available in retention ratings of 0.03, 0.05, 0.1, 0.2 µm	Provides excellent small particle retention to ensure minimal particles remain on water surface.
Available in cartridge and disposable filter designs	Disposable filters require less space for changeout. Allows quick installation and minimizes downtime while limiting the handling of hazardous chemicals during the installation and disposal processes, thereby promoting a more healthy workplace.

## Optimizer DEV and DI Disposable Filters

### Integrated Design Provides Safe Handling

A small and easy-to-handle polypropylene housing encases Optimizer DEV and DI filters. The integrated design allows quick installation and a minimum amount of downtime. This design also limits the handling of hazardous chemicals during the installation and promotes a healthier workplace.

### Compatibility

The Optimizer DEV filter is recommended for use in positive developer solutions but can also be used in DI water applications. The Optimizer DI filter is not recommended for developer applications. It swells and reduces flow in high pH conditions. Do not use either filter with aromatic hydrocarbons.

### Membranes Designed to Minimize Dewetting

Traditionally, smaller pore sizes increase dewetting potential. Optimizer filters decrease dewetting potential. With membranes that match the characteristics of the fluids, these filters minimize the chance that membranes will dewet. (If a membrane dewets, it can create a dry spot, leading to a nucleation site. This can result in microbubble formation.)

Traditionally, users obtain better results when the substrate surface energy is higher than base fluid surface tension.

### Flow Properties Maintain Low Differential Pressure

The Optimizer DEV filter works in DI water and positive developer solutions. It provides excellent flow while maintaining instant wettability. The newest addition to this family is the Optimizer DEV 30 nm, which has more membrane area in the same form factor, allowing improved retention and better flow. The Optimizer DI filter membrane works best in DI water. It provides excellent flow and additional ion uptake performance without risking the filter's instant wetting capability.

### Manufactured at an ISO 9000 Registered Facility

To ensure reliability, Entegris manufactures Optimizer filters in a facility registered to the ISO 9002 Quality Systems Standard and tests these filters for 100% integrity.

### Specifications

Materials	Membrane	Patented surface-modified hydrophilic ultra-high molecular weight polyethylene (UHMWPE)
	Supports	High-density polyethylene (HDPE) supports, core and sleeve
	Disposable shell	Polypropylene
Filtration area:	DI/DEV	1800 cm <sup>2</sup> (279 in <sup>2</sup> )
	DI-L/DEV-L	3600 cm <sup>2</sup> (558 in <sup>2</sup> )
	DI-L 20 nm	2100 cm <sup>2</sup> (326 in <sup>2</sup> )
	DEV 30 nm	2600 cm <sup>2</sup> (279 in <sup>2</sup> )
	DEV-L 30 nm	4500 cm <sup>2</sup> (558 in <sup>2</sup> )
Fittings:	Available in a wide range of fittings including Super Type Pillar® fittings, compression seal (Swagelok® compatible fittings) and Flaretek® fittings	
Operating conditions:	Maximum operating pressure	0.345 MPa (3.45 bar; 50 PSID) @ 25°C (77°F)
	Maximum forward differential pressure	0.28 MPa (2.8 bar; 41 PSID) @ 25°C (77°F)
	Maximum reverse differential pressure	0.28 MPa (2.8 bar; 41 PSID) @ 25°C (77°F)
	Maximum operating temperature	60°C (140°F)

**Performance Data**

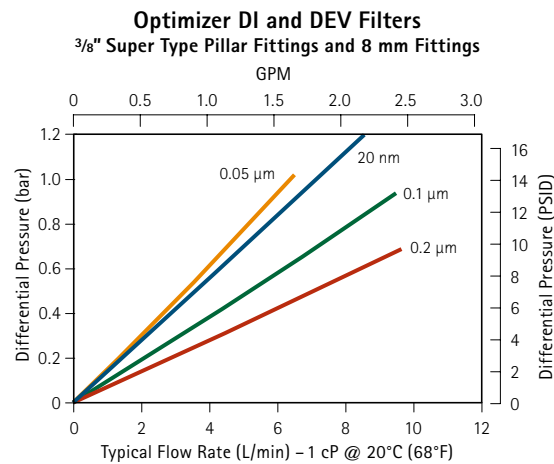
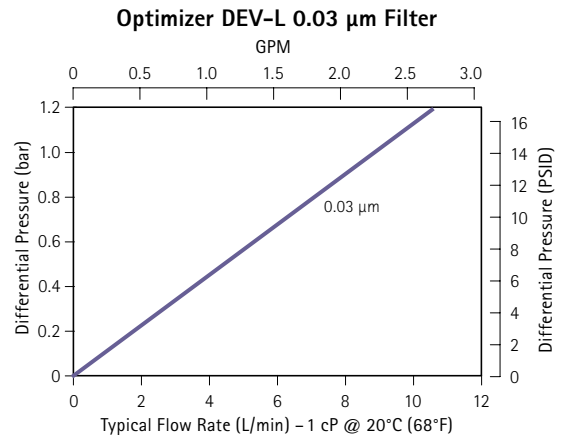
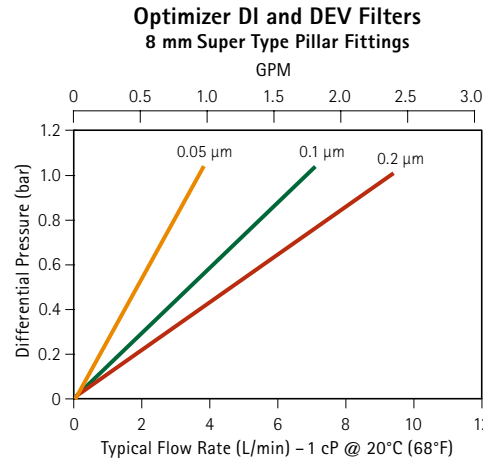
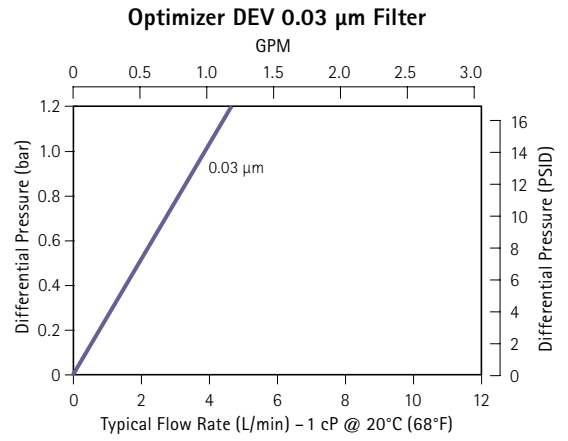
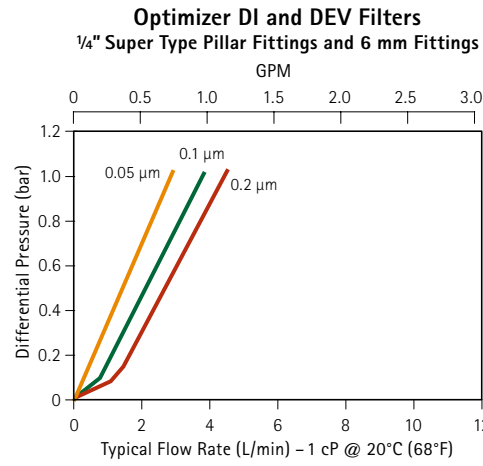

**Dimensions**

**Optimizer DEV-L/DI-L Filter**

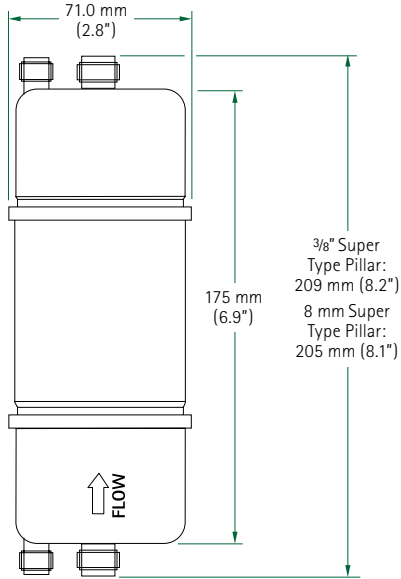

**Optimizer DEV/DI Filter**

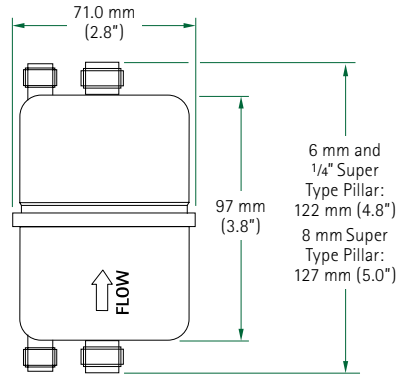

**Ordering Information**

**DEV Disposable Filters**

**Part Number**

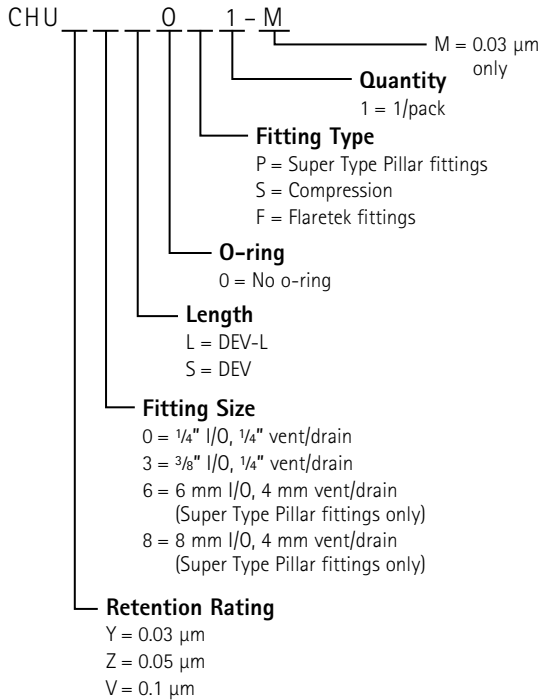

**DI Disposable Filters**

**Part Number**

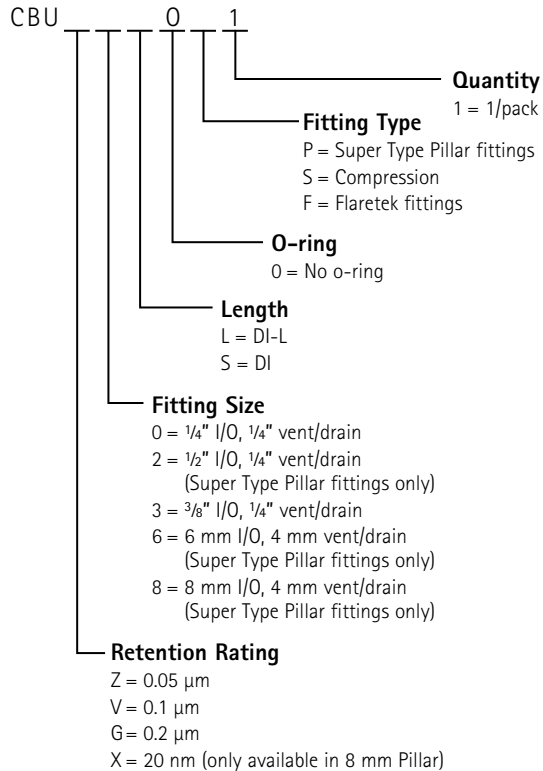

Note: Not all combinations are available. Please consult your local sales representative.

## Optimizer DEV and DI Cartridge Filters

### Specifications

Materials:	Membrane	Patented surface-modified hydrophilic ultra-high molecular weight polyethylene (UHMWPE)
	Supports	High-density polyethylene (HDPE) supports, end caps, support, cage, core
	O-rings	EPDM, Kalrez® perfluoroelastomer or Teflon® fluoropolymer encapsulated Viton® fluoroelastomer (TEV)
Filtration area:	16-stack	1600 cm <sup>2</sup> (248 in <sup>2</sup> )
	40-stack	3200 cm <sup>2</sup> (496 in <sup>2</sup> )
Operating conditions:	Maximum operating pressure	0.345 MPa (3.45 bar; 50 PSID) @ 20°C (68°F)
	Maximum forward differential pressure	0.27 MPa (2.7 bar; 40 PSID) @ 25°C (77°F)
	Maximum reverse differential pressure	0.27 MPa (2.7 bar; 40 PSID) @ 25°C (77°F)
	Maximum operating temperature	60°C (140°F)

### Performance Data

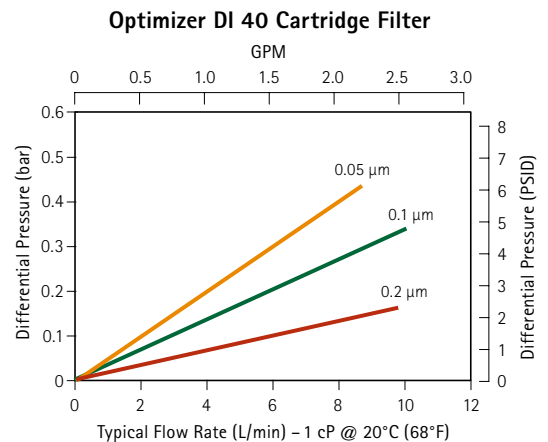
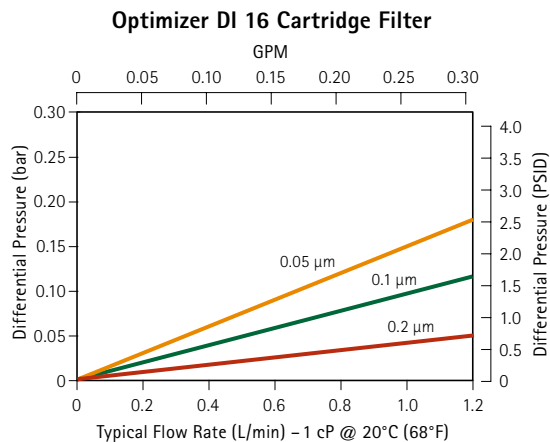
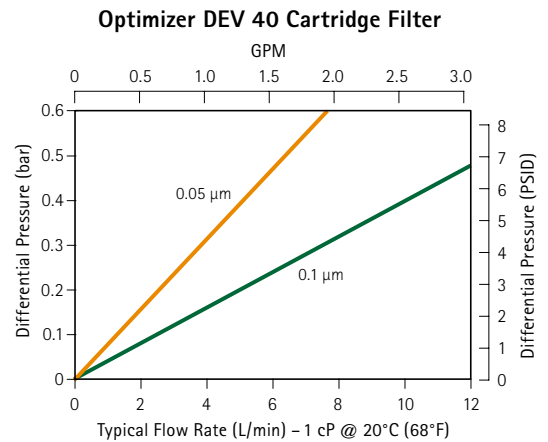
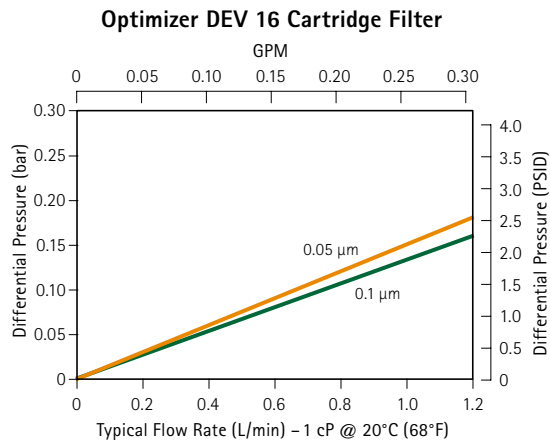

**Dimensions**

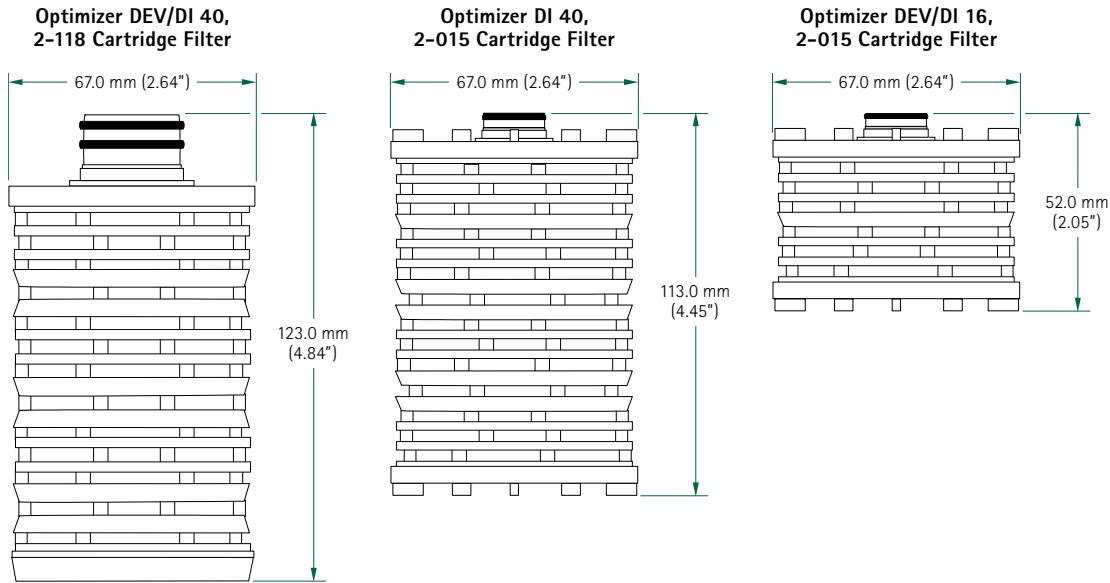

**Ordering Information**

**DEV Cartridge Filters**

**Part Number**

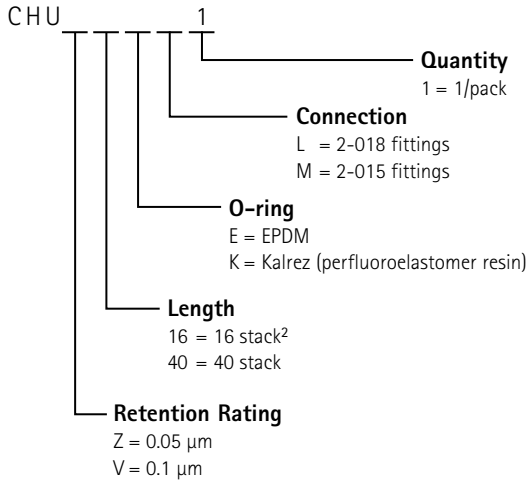

**DI Cartridge Filters**

**Part Number**

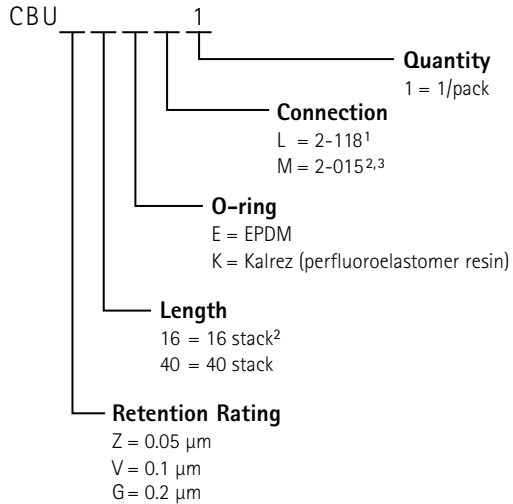

<sup>1</sup> 2-118 connection available for 40 size only and is designed for use with the Wafergard® ECTFE 40-stack housing.

<sup>2</sup> 16 size available with "E" or "K" o-rings only and in 2-015 connection only; 16-stack is designed for use with the Wafergard Chemical Dispense System (WCDS-2) 16-stack or the stainless steel F-16 housing.

<sup>3</sup> 40 size with 2-015 connector is available with "E" o-rings only; 40-size is designed for use with the WCDS-2 40-stack or the stainless steel F-40 housing.

Note: Not all combinations are available. Please consult your local sales representative.

## For More Information

Please call your Regional Customer Service Center today to learn what Entegris can do for you. Visit [www.entegris.com](http://www.entegris.com) and select the Customer Service link for the center nearest you.

## Terms and Conditions of Sale

All purchases are subject to Entegris' Terms and Conditions of Sale. To view and print this information, visit [www.entegris.com](http://www.entegris.com) and select the Legal Notices link from the footer.

Entegris®, Flaretek®, Wafergard® and Optimizer® are registered trademarks of Entegris, Inc.  
Teflon® is a registered trademark of E.I. du Pont de Nemours used under license.  
Pillar® is a registered trademark of Nippon Pillar Packing Company, Ltd.  
Swagelok® is a registered trademark of Swagelok Company.  
Kalrez® and Viton® are registered trademarks of DuPont Dow Elastomers, L.L.C.

---

### ENTEGRIS, INC.

Corporate Headquarters | 129 Concord Road | Billerica, MA 01821 USA  
Customer Service Tel. +1 952 556 4181 | Customer Service Fax +1 952 556 8022  
In North America 800 394 4083 | [www.entegris.com](http://www.entegris.com)